

HR-2 Harmonist

Owner's Manual

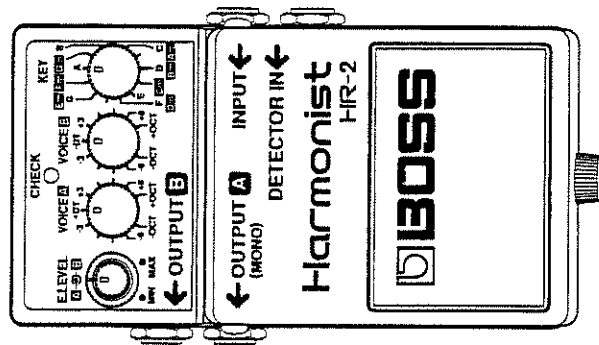

AC & BATTERY
POWERED



BOSS



This product complies with the requirements of European Directive 89/336/EEC.

For EU Countries

Bescheinigung des Herstellers/Importeurs

For Germany

Hiermit wird bescheinigt, daß der/die/das
HARMONIST HR-2

(Gerät, Typ, Bezeichnung)

Dem Zentralamt für Zulassungen im Fernmeldewesen wurde das Inverkehrbringen dieses Gerätes angezeigt und die Berechtigung zur Überprüfung der Serie auf die Einhaltung der Bestimmungen eingeräumt.

in Übereinstimmung mit den Bestimmungen der BMP-T-A
Amtsbl/Vfg 243/1991, 46/1992 funk-entsförlt ist.

Roland Corporation

4-16 Dojimahama 1-Chome Kita-ku Osaka 530 Japan

Der vorschriftsmäßige Betrieb mancher Geräte (z. B. Meßsender) kann allerdings gewissen Einschränkungen unterliegen. Beachten Sie deshalb die Hinweise in der Bedienungsanleitung.

(Name und Anschrift des Herstellers/Importeurs)

Thank you, and congratulations on your choice of the BOSS HR-2 Harmonist. To ensure proper operation and years of trouble-free service, please take the time to read through this Owner's Manual before starting out.

FEATURES

- By selecting the proper key, you can instantly add a two-part harmony to whatever single-note melody you play!
- The pitch and volume of each harmony part can be set independently.
- The HR-2 can also create octave and 'detune' effects.

Copyright © 1994 BOSS Corporation

All rights reserved. No part of this publication may be reproduced in any form without the permission of BOSS Corporation.

The HR-2 can detect the scale of a musical instrument, then outputs the appropriate harmonies. To obtain the best results, make sure you have your instrument tuned correctly. Inaccurate tuning will result in inappropriate harmonies. A4 should be tuned so it has a pitch of 440 Hz.

The HR-2 is designed to recognize individual notes one at a time, so you must not play chords.

Should you wish to input the signal coming from another effects unit, you will need to use the optional J-5 Multiple Jack (or the like) so you can directly feed the guitar sound to the Detector In Jack on the HR-2. If you simply connect the output from the other effects unit to the HR-2 without inputting to Detector In, the pitch of the harmonies may be inaccurate. For details on setups using the Detector In Jack, see page 12, "HOW TO USE THE DETECTOR IN JACK."

IMPORTANT NOTES

When using an AC adaptor, use only the specified device (PSA Series). Use of any other AC adaptor could result in damage, malfunction or electric shock.

POWER SUPPLY

The power requirement for this unit is indicated on its nameplate (rear panel). Ensure that the voltage in your installation meets this requirement.

If the unit is to remain unused for an extended period of time, unplug the power cord.

PLACEMENT

Do not subject the unit to temperature extremes (eg., direct sunlight in an enclosed vehicle). Avoid using or storing the unit in dusty or humid areas, or areas that are subject to high levels of vibration.

ADDITIONAL PRECAUTIONS

Protect the unit from strong impact.

Should a malfunction occur, or if you suspect there is a problem, discontinue use immediately. Contact qualified service personnel as soon as possible.

To avoid the risk of electric shock, do not open the unit.

CHANGING THE BATTERY

Remove the battery whenever the unit is to remain unused for an extended period of time.

PANEL DESCRIPTIONS

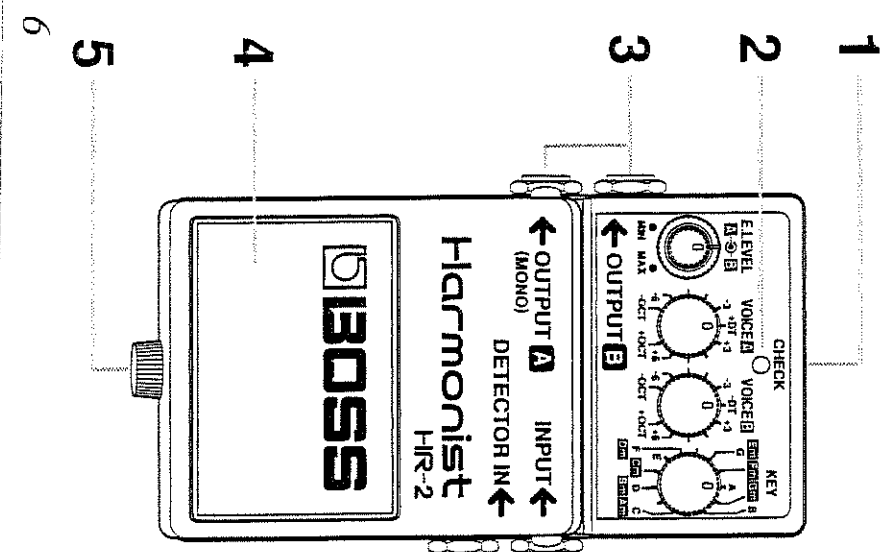

1. AC Adaptor Jack

Accepts connection of an AC adaptor (BOSS PSA-Series; optional). By using an AC adaptor, you can play without being concerned about how much battery power you have left.

** As soon as you connect the AC adaptor, the unit is turned ON.*

** You may find that it is a good idea to keep a battery installed in the unit even while using an adaptor. That way your playing won't be disrupted even if the adaptor is accidentally disconnected.*

** If you are going to use an AC adaptor, be sure to use the specified unit (BOSS PSA-Series). Use of any other adaptor may result in damage, malfunction or electric shock. In addition, if you are not going to be using it for an extended period of time, disconnect the AC adaptor from the AC outlet.*

2. CHECK Indicator

This LED indicates whether the effect is ON/OFF, and also doubles as a battery check. The indicator lights when the effect is ON. If this indicator goes dim or no longer lights while the

effect is ON, the battery is near exhaustion and should be replaced immediately.

3. OUTPUT Jacks A(MONO)/B

The output jacks are used to connect the unit to amplifiers or other devices. The harmony parts set with the VOICE A and B knobs will be output to OUTPUTs A/B. To output a monaural signal, use only the A(MONO) jack (VOICEs A/B will be output through A(MONO)).

4. Pedal Switch

This switch turns the unit ON/OFF.

5. Thumbscrew

This thumbscrew is loosened to open the pedal, allowing battery replacement. For instructions on how to replace the battery, please refer to "CHANGING THE BATTERY" on page 16.

6. INPUT Jack

This jack accepts input signals (coming from a guitar, some other electric or electronic musical instrument, or another effects unit).

** When you direct the output signal from an external effects unit to the HR-2, be sure to input the guitar sound directly to the DETECTOR IN Jack. If you connect the output signal of the other effects unit without using DETECTOR IN, the pitch of the harmony will be inaccurate.*

** The INPUT Jack also serves as the power switch while using the unit on battery power. Power is turned on whenever a plug is inserted into the INPUT Jack, and is turned off when the plug is disconnected. When not using the unit, you should disconnect any cord connected to the INPUT Jack.*

7. DETECTOR IN Jack

The input jack is used to detect the pitch of a musical instrument. When you connect an effects unit before the HR-2, be sure to input the guitar signal directly into the DETECTOR IN Jack.

** For a detailed explanation on the connections using the "DETECTOR IN Jack", see page 12 "HOW TO USE THE DETECTOR IN JACK".*

EFFECT LEVEL Knobs A/B

VOICE Switches A/B

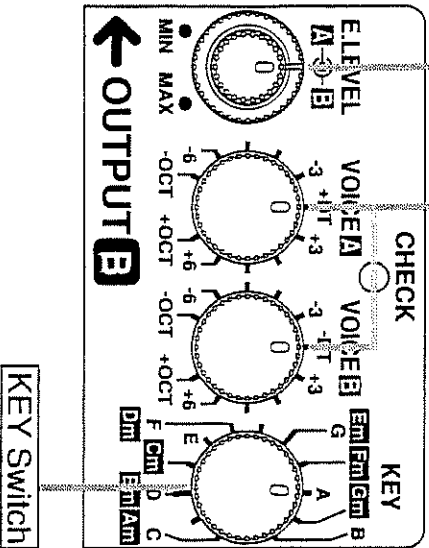

These knobs are used to adjust the volume of voices (harmony parts) A and B.

EFFECT LEVEL Knobs A/B

** If an ELEVEL Knob (A/B) is rotated completely counterclockwise, no effect sound will be heard.*

VOICE Switches A/B

These knobs adjust the harmonic interval of voices A and B. You can select any of the following settings: a 3rd, 4th, 5th, 6th or 1 octave. For a detailed explanation, see page 13 "HOW TO SET THE VOICE SWITCHES A/B".

Regarding the harmony parts that are output, see page 14 "ABOUT THE SCALE OF THE EFFECT SOUND".

KEY Switch

This knob allows you to select the key that corresponds to the song to be played. The HR-2 then creates one or two harmony parts appropriate for each individual input sound.

** If you fail to select the proper key for the song, the harmony parts will not be of the correct harmonic interval.*

MAKING THE CONNECTIONS

- * Inserting a plug into the INPUT Jack will automatically switch the unit on.*
- * Before connecting or disconnecting any patch cords, be sure all the volume controls in your system are set to minimum; this will help prevent any damage to system components.*

The following illustrates how to connect a guitar directly to the HR-2. If you wish to connect another effects unit before the HR-2, refer to "HOW TO USE THE DETECTOR IN JACK" on page 12.

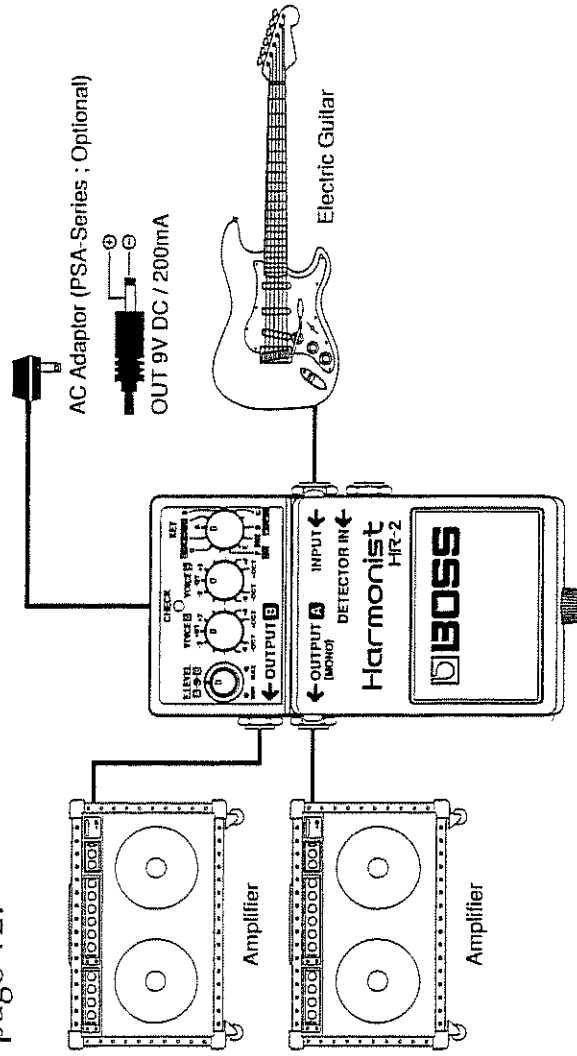

OPERATING THE UNIT

We recommend that you use a tuner to make sure that your instrument is perfectly tuned.

1. When you have made the necessary connections, set the knobs as shown in the illustration.
2. Depress the pedal switch to turn the effect on. (Be sure the CHECK Indicator lights.)
3. Set the key for the song to be played using the KEY Switch.

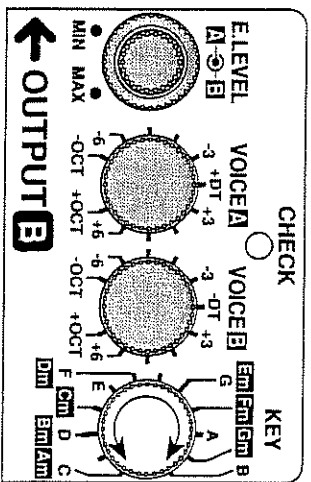
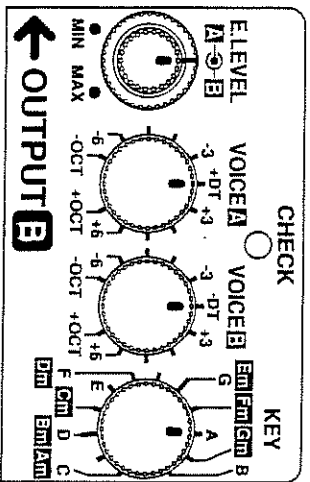

4. Set the harmonic interval of voices A and B separately using VOICE Switches A/B.
5. Adjust the volumes of voices A and B separately using the E. LEVEL Knobs A/B.

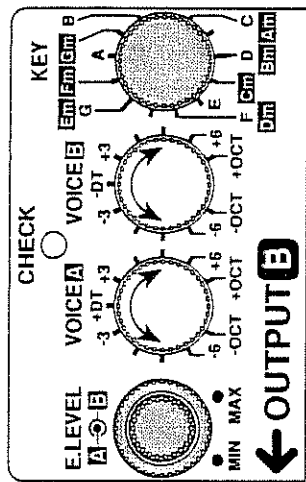
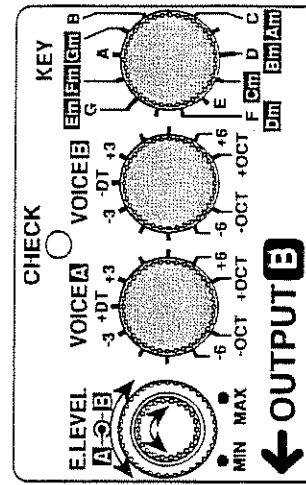

HOW TO USE THE DETECTOR IN JACK

When you input a signal from another effects unit into the HR-2, be sure to input the guitar sound directly to the DETECTOR IN Jack using a Multiple Jack J-5 (optional) etc. If you try to input the signal without using the DETECTOR IN, the pitch of the harmony may be inaccurate. For a detailed explanation about how to make the connections, see the following diagram.

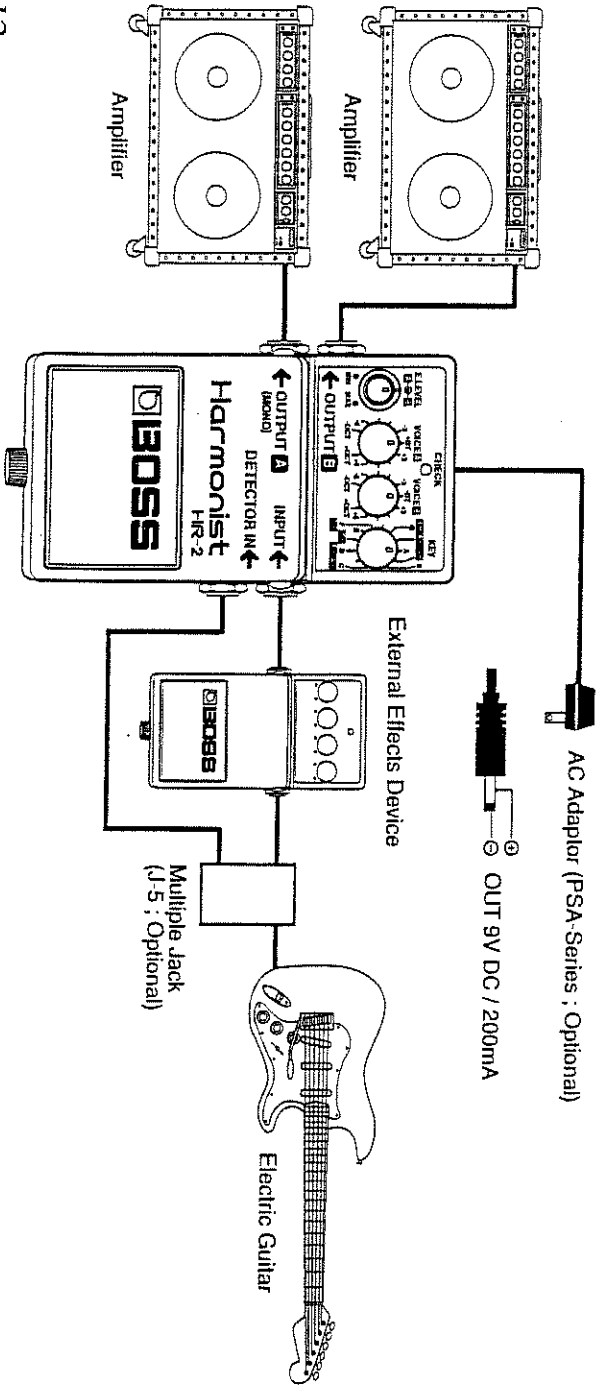

HOW TO SET THE VOICE SWITCHES A/B

These knobs allow you to set the harmonic interval of voices A and B separately. The output harmony will be as follows:

+DT/-DT (+/- Detune) :

These settings add a sound that is slightly 'detuned' from the original input sound. The resulting sound is somewhat 'fatter' and more full than the straight input sound. Voice Switch A creates +DT settings that are higher than the input sound, and Voice Switch B creates -DT settings that are lower than the input sound.

-6/-5/-4/-3/+3/+4/+5/+6 (3rd, 4th, 5th, 6th) :

Plus or minus a 3rd to a 6th sound will be added to the input sound, creating a harmony part.

+OCT/-OCT (+/- 1 octave) :

A sound plus or minus 1 octave will be added to the input sound, creating an octave harmony part.

** If you set these two Voice Switches to the same harmonic interval, VOICE A outputs the harmony at the set harmonic interval, while VOICE B outputs the harmony with a Detune effect.*

ABOUT THE SCALE OF THE EFFECT SOUND

The HR-2 creates its harmony parts based upon the key of the song selected and the unit's other panel settings. The keys that can be set on the HR-2 are majors and minors of all the scales. For example, if you select "C(Am)", the resulting harmony will be as shown below:

UP

| | | | | | | | | | | | | |
|--------------|----------|-----------|----------|-----------|----------|----------|-----------|----------|-----------|----------|-----------|----------|
| +5 (-4) | G | G | A | A | B | C | C | D | D | E | E | F |
| +3 (-6) | E | E | F | F# | G | A | A | B | B | C | C# | D |
| INPUT | C | C# | D | D# | E | F | F# | G | G# | A | A# | B |
| -3 (+6) | A | A# | B | B | C | D | D | E | E | F | F# | G |
| -5 (+4) | F | F# | G | G# | A | B | B | C | C# | D | D# | E |

DOWN

| | | | | | | | | | | | | |
|--------------|----------|----------|-----------|----------|-----------|----------|-----------|----------|----------|-----------|----------|-----------|
| +5 (-4) | G | F | F | E | D | D | C | C | B | A# | A | G# |
| +3 (-6) | E | D | C# | C | B | B | A | A | G | F# | F | F |
| INPUT | C | B | A# | A | G# | G | F# | F | E | D# | D | C# |
| -3 (+6) | A | G | G | F | E | E | D | D | C | C | B | A# |
| -5 (+4) | F | E | E | D | C# | C | B | B | A | A | G | G |

KEY SETTING

The KEY setting you should choose for the music you play will vary as shown below depending on the key signature (#, b) in the music score.

Major C F B^b E^b A^b D^b G^b

A musical staff in treble clef showing a sequence of notes: C, F, B-flat, E-flat, A-flat, D-flat, G-flat. The notes are written on a five-line staff with a key signature of two flats.

Minor Am Dm Gm Cm Fm B^bm E^bm

A musical staff in treble clef showing a sequence of notes: A, D, G, C, F, B-flat, E-flat. The notes are written on a five-line staff with a key signature of two flats.

Major G D A E B F[#]

A musical staff in treble clef showing a sequence of notes: G, D, A, E, B, F-sharp. The notes are written on a five-line staff with a key signature of one sharp.

Minor Em Bm F[#]m C[#]m G[#]m D[#]m 15

A musical staff in treble clef showing a sequence of notes: E, B, F-sharp, C-sharp, G-sharp, D-sharp. The notes are written on a five-line staff with a key signature of two sharps.

CHANGING THE BATTERY

When the indicator goes dim or no longer lights while the unit is on, it means that the battery is nearly dead and must be replaced. Replace the battery following the steps below.

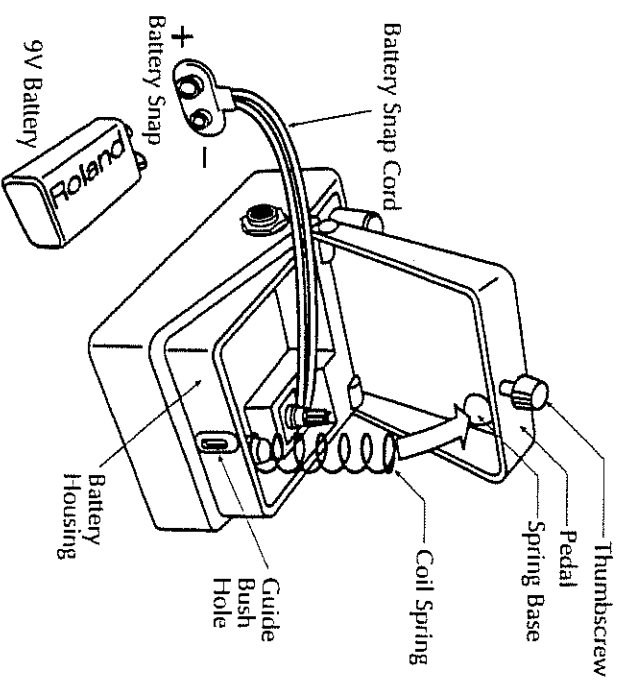

1. Loosen the thumbscrew at the front of the pedal, then lift the pedal upwards to open the unit.

** The thumbscrew can be left in the pedal while changing the battery.*

2. Remove the battery from the battery housing and disconnect the snap cord connected to it.

3. Connect the snap cord to the new battery and place the battery inside the battery housing.

** Be sure to observe battery polarity (+/-).*

4. Slip the coil spring onto the spring base on the back of the pedal and then close the pedal.

** Avoid getting the snap cord caught in the coil spring.*

5. Finally, insert the thumbscrew into the guide hole and fasten securely.

SAMPLE SETTING

Twin Lead 1

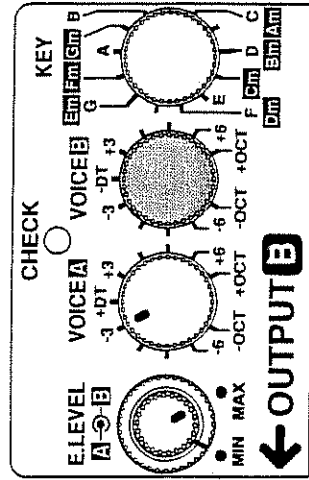

Twin Lead 2

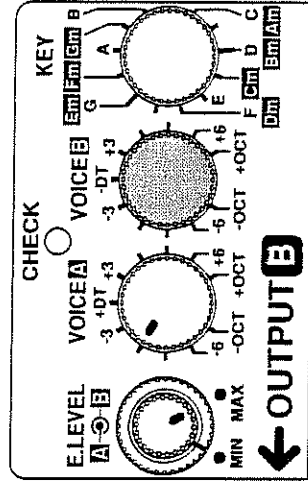

Unison Play

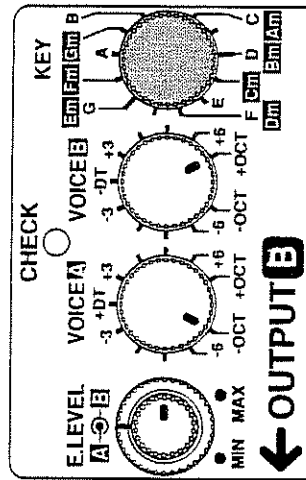

Detuned Sound

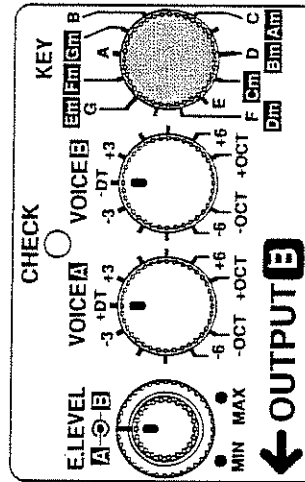

Harmony Pattern 1

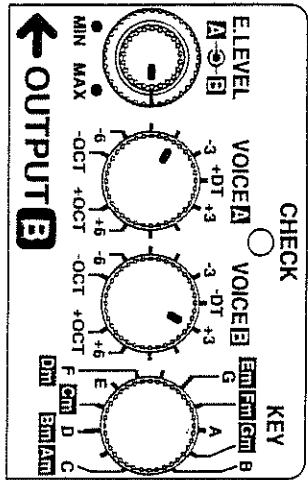

Harmony Pattern 2

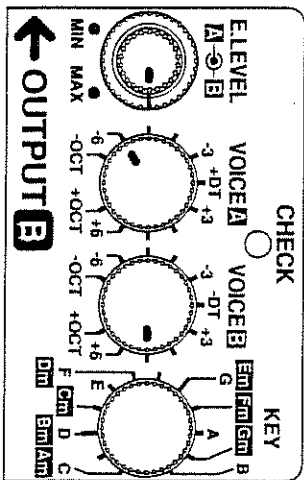

Harmony Pattern 3

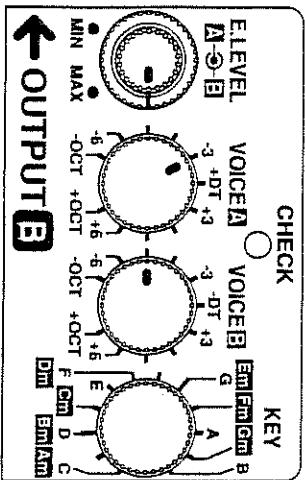

Harmony Pattern 4

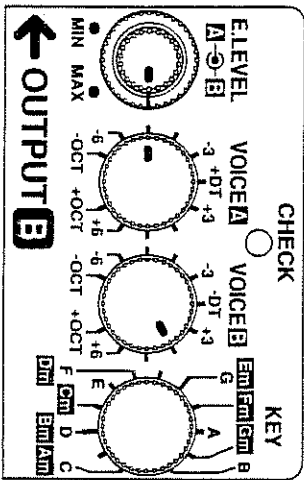

SETTING MEMO

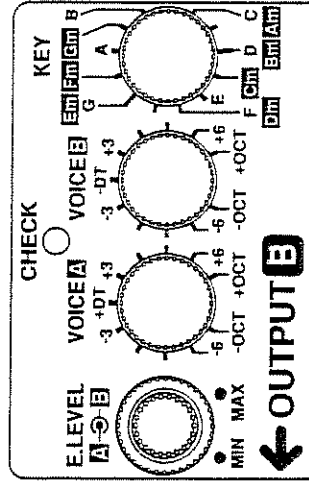
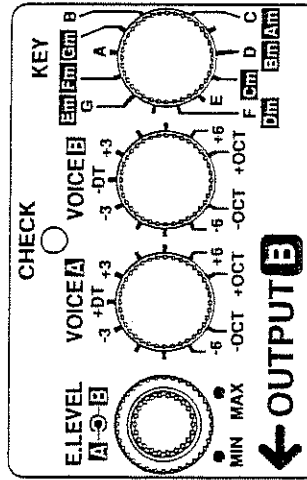
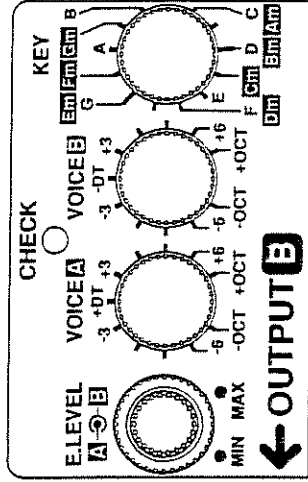
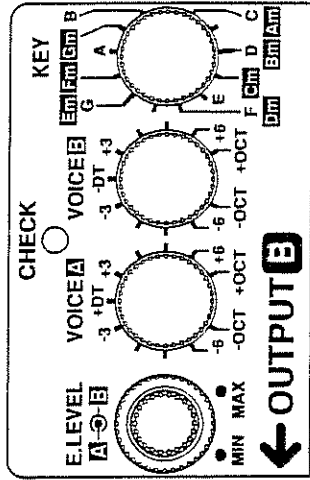

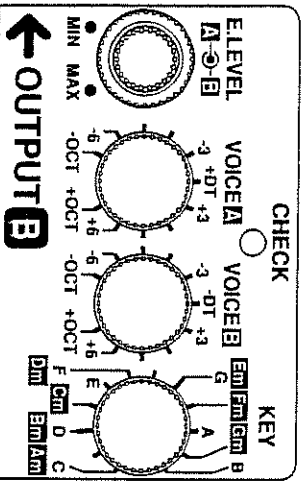
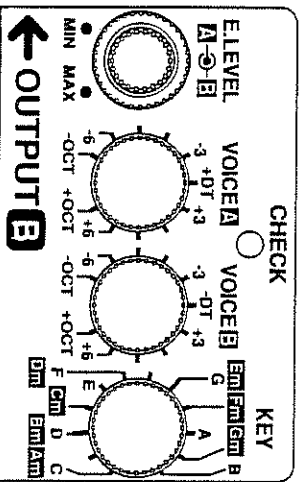
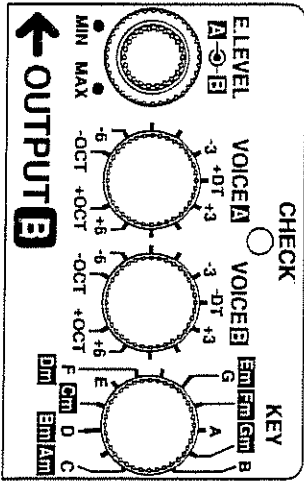
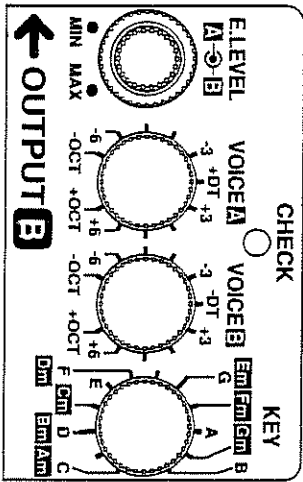

SPECIFICATIONS

HR-2 : Harmonist

A/D Conversion 16 bit linear, 128 times oversampling, $\Delta\Sigma$ modulation, AF Method
D/A Conversion 16 bit linear
Sampling Frequency 32 kHz
Nominal Input Level -20 dBm
Input Impedance 1 M Ω
Nominal Output Level -20 dBm
Output Impedance 1 k Ω
Dynamic Range 110 dB or greater (Direct)
90 dB or greater (Effect)

Controls Pedal Switch, E.LEVEL Knobs A/B, VOICE Switches A/B,
KEY Switch
Indicator CHECK Indicator (serves also as a battery check)
Connectors INPUT Jack, OUTPUT Jacks A(MONO)/B, DETECTOR IN Jack,
AC Adaptor Jack (9 V DC)

About the AF Method (Adaptive Focus Method)
This new method dramatically reduces quantization noise by carrying out the digitization (A/D) in a manner that is optimum for the input signal.

Power Supply 9 V DC: Dry Battery 9 V type (6AM6/9 V); AC Adaptor
Current Draw 75 mA (9 V DC)

** Expected battery life under continuous use:*

Alkaline: 5 hours

These figures will vary depending upon the actual conditions of use.

Dimensions 70 (W) x 125 (D) x 55 (H) mm
2-3/4 (W) x 4-15/16 (D) x 2-3/16 (H) inches
Weight 420 g / 15 oz (including battery)
Accessories Owner's Manual, Dry Battery 9 V type (6AM6/9 V), Roland Service
Options AC Adaptor PSA-Series, Multiple Jack J-5

** 0 dBm = 0.775 V rms*

** In the interest of product development, the specifications and/or appearance of this unit are subject to change without prior notice.*

For the USA

FEDERAL COMMUNICATIONS COMMISSION RADIO FREQUENCY INTERFERENCE STATEMENT

This equipment has been tested and found to comply with the limits for a Class B digital device, pursuant to Part 15 of the FCC Rules. These limits are designed to provide reasonable protection against harmful interference in a residential installation. This equipment generates, uses, and can radiate radio frequency energy and, if not installed and used in accordance with the instructions, may cause harmful interference to radio communications. However, there is no guarantee that interference will not occur in a particular installation. If this equipment does cause harmful interference to radio or television reception, which can be determined by turning the equipment off and on, the user is encouraged to try to correct the interference by one or more of the following measures:

- Reorient or relocate the receiving antenna.
- Increase the separation between the equipment and receiver.
- Connect the equipment into an outlet on a circuit different from that to which the receiver is connected.
- Consult the dealer or an experienced radio/TV technician for help.

Unauthorized changes or modification to this system can void the users authority to operate this equipment.
This equipment requires shielded interface cables in order to meet FCC class B Limit.

For Canada

CLASS B

This digital apparatus does not exceed the Class B limits for radio noise emissions set out in the Radio Interference Regulations of the Canadian Department of Communications.

NOTICE

CLASSE B

Cet appareil numérique ne dépasse pas les limites de la classe B au niveau des émissions de bruits radioélectriques fixés dans le Règlement des signaux parasites par le ministère canadien des Communications.

AVIS

 Roland®

10922

UPC 10922



10922

 **BOSS**

Printed in Taiwan '98-11-B3-2C G601725101